

Compact Sensor

SPECIFICATION

The Enlighted Compact Sensor's small form factor and flush mount design enable the sensor to blend into its surroundings while it senses occupancy, ambient light, and temperature. The sensor processes this information locally, creating a rich set of data that is backhauled wirelessly through the intelligent Enlighted IoT Platform. The sensor also receives and transmits beacons and data using the Bluetooth® Low Energy (BLE) protocol.

OVERVIEW

Designed for indoor lighting applications, the Enlighted Compact Sensor features onboard intelligence that is unparalleled in the industry. With digital motion, ambient light, and temperature sensing, the device provides autonomous fixture-level control in a compact form factor, bringing advanced lighting automation to a whole new scale. The device can be mounted in a fixture or into the ceiling, leaving only the sensor face visible. This makes it an ideal choice for maintaining aesthetics.

FEATURES AND BENEFITS

Localized Control: Local microprocessor and memory in each sensor enable a sequence of operations at the fixture, eliminating dependency on any other network component once system setup is complete. The sensor works autonomously to ensure continuous operation, eliminating any single point system failure.

Software-Driven: Light-level schedules, preferences, and behavior profiles for each fixture are wirelessly communicated during system setup and locally stored. Profiles can be modified and updated wirelessly.

Occupancy/Thermal Sensing: Digital Passive Infrared (PIR) detection with separate ambient light and temperature sensors support precise motion sensing while minimizing false detection events.

Tunable White: When used with a compatible pair of LED drivers, the sensor is capable of controlling the color temperature of a fixture along with the dim level. Also, when used with Energy Manager 3.6 and above, the sensor supports color transitions based on circadian rhythm.

Manual-on/Vacancy Sensing: When paired with the Wireless Room Control (WS-2-00), the sensor acts as a vacancy sensor providing code-compliant manual-on/auto-off capability.

Bluetooth 4.0: An embedded BLE radio allows the sensor to receive and transmit beacons in addition to Bluetooth data communication.

Daylight Harvesting: An ambient light sensor captures light level data from the coverage area. The sensor then interprets this data and transmits code-compliant control commands to the Enlighted Control Unit to raise and lower light levels based on available daylight.

Zone Control: Sensors can be grouped into zones, thereby allowing multiple fixtures to share occupancy sensing data and respond simultaneously to occupant motion patterns.

Full Reporting Functions: Local occupancy, power consumption, light level and temperature data collection compatible with Enlighted's control network can enable local analysis and provide custom reports.

Standards-Based Networking and Security: The Enlighted 802.15.4 wireless network with AES-128 encryption supports reliable communication that coexists with Wi-Fi networks by sensing low-traffic channels and transmitting in bursts.

Simple and Low-Cost Installation: Single wiring connection in a fixture with no other above ceiling wiring required. One-sensor-per-fixture approach simplifies the installation process.

Lighting Technology Compatibility: The sensor can send dimming controls to standard 0-10V ballasts and drivers for LED, fluorescent, High Intensity Discharge (HID), induction, or plasma fixtures and on/off controls for all types of fixtures and relays.



Compact Sensor

Body	L	1.87"	47.5mm
	Dia.	.82"	20.8mm
Bezel	Dia.	1.26"	32.0mm

ENLIGHTED SPECIFICATION SUBMITTAL

Job Name:

Job Number:

Product Codes:

 SU-4E-01

 CBL-3-30N

 CBL-3-12N

 CBL-3-7F

 CBL-3-15F

 CBL-3-30F

 CBL-3-50F

 CBL-4-7F-2CH

 CBL-4-30N-OSR

Cables (CBL) are Cat3 with an RJ12 connector on one side and a proprietary Enlighted connector on the other side. Cables must be purchased through Enlighted.

Compact Sensor



MOUNTING

The Enlighted Compact Sensor is designed to be easily mounted into lighting fixtures or ceiling tiles so that only the discrete paintable white faceplate is visible.

To mount the sensor in a lighting fixture, insert the sensor through a 1/2 inch trade size knockout or 7/8" inches (22mm) hole. Thread the Enlighted spring arms (not pictured) around the back of the sensor to fasten it in place inside the fixture. To mount the sensor through a ceiling tile, thread the spring arms around the sensor and insert the sensor through a 15/16th inch hole in the tile. The spring arms hold the sensor in place—no access to the back of the tile is required.

SENSOR COVERAGE PATTERNS

The Enlighted Compact Sensor uses infrared technology to detect occupancy. The human body emits heat as infrared light. The sensor incorporates a multi-faceted lens to focus this light onto a Passive Infrared (PIR) detector. Using patented algorithms, the Compact Sensor analyzes the PIR's output and determines if a person is present. The Enlighted Compact Sensor produces an all-encompassing field of view by aggregating many repeated narrow field of views.

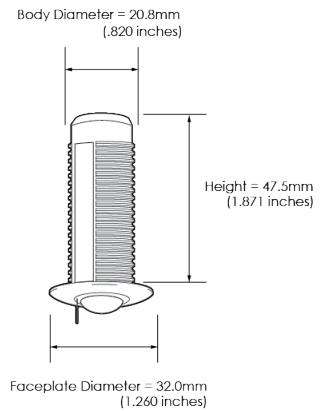

Ceiling Height	Minor Motion (Radius)	Major Motion (Radius)
8.5 feet/2.6m	5 feet/1.5m	10 feet/3m
16 feet/12m	9 feet/2.8m	18 feet/5.5m

8.5 feet Mounting Height

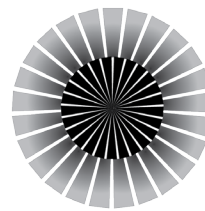
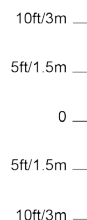
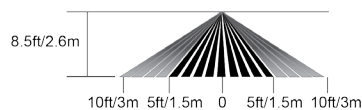

16 feet Mounting Height

Top View

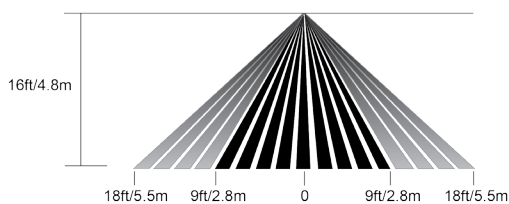

■ Minor Motion
■ Major Motion

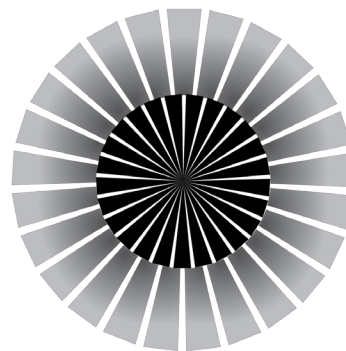
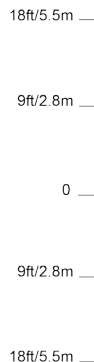

TECHNICAL SPECIFICATIONS

Motion Sensing: Digital Passive IR

Photosensor: Light Pipe/Photosensor Array

Enclosure: ABS/Polycarbonate blend

Type: Closed Loop Light Sensor

Operating: 32° to 122° F / 0° to 50° C

Radio Frequency: 2400–2483.5 MHz

Wireless Protocol: IEEE 802.15.4

Wireless Range: 150 ft (46m) radius open range

Encryption: AES-128

Bluetooth 4.0 Low Energy (BLE):

Operating Frequency: 2400–2483.5 MHz
IEEE Standard: 802.15.1

ORDERING INFORMATION

SU-4E-01	Compact Sensor
CBL-3-30N	30 inch SU-3E Sensor Cable
CBL-3-12N	12 inch SU-3E Sensor Cable
CBL-3-7F	7 ft SU-3E Sensor Cable
CBL-3-15F	15 ft SU-3E Sensor Cable
CBL-3-30F	30 ft SU-3E Sensor Cable
CBL-3-50F	50 ft SU-3E Sensor Cable
CBL-4-7F-2CH	7 ft Dual-channel Tunable White Cable
CBL-4-30N-OSR	30 inch OSRAM Drive Cable

COMPLIANCE



Warranty: 5 years

Refer www.enlightedinc.com/limited-warranty-terms for complete terms and conditions

Bluetooth: The Bluetooth® word mark and logos are registered trademarks owned by Bluetooth SIG, Inc. and any use of such marks by Enlighted Inc. is under license. Other trademarks and trade names are those of their respective owners.

930 BENEZIA AVENUE, SUNNYVALE CA 94085 | PHONE 650.964.1094 | enlightedinc.com

93-01654-01 Rev06 062717